

AMP-TWIST 6AS SL Jack 1711592-[] and 1711716-[]

AMP-TWIST-6AS SL JACK
PN 1711592-[] or 1711716-[]

CABLE REQUIREMENTS
(Product Spec.108-93028)

TOOL: PN 1725150-3
SPACER: 1711880-1

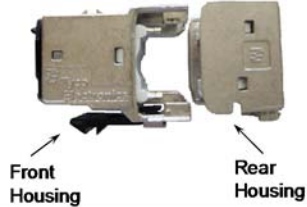

Solid conductor range	AWG 22-24	✓
Stranded conductor	AWG 24	✓
Max. Insulation Ø (mm.)	1.60	✓
Cable Ø (mm.) range	5.0 - 9.0	✓

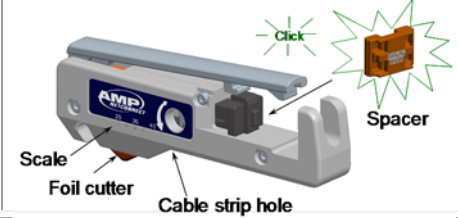

CABLE PREPARATION: S/FTP ("PiMF")

S/FTP



Dimensions are in mm.
Figures are for ref. only

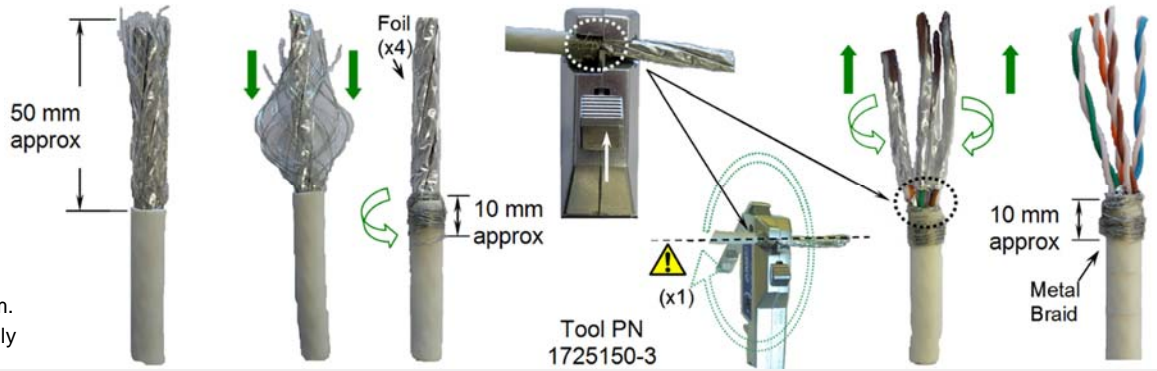

CABLE PREPARATION: F/FTP ("Compact")

F/FTP



Dimensions are in mm.
Figures are for ref. only

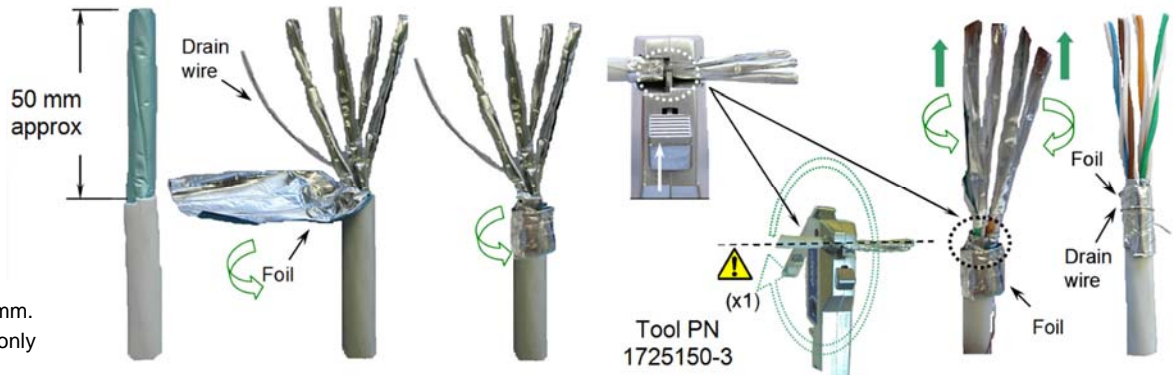

CABLE PREPARATION: F/UTP

F/UTP



Dimensions are in mm.
Figures are for ref. only

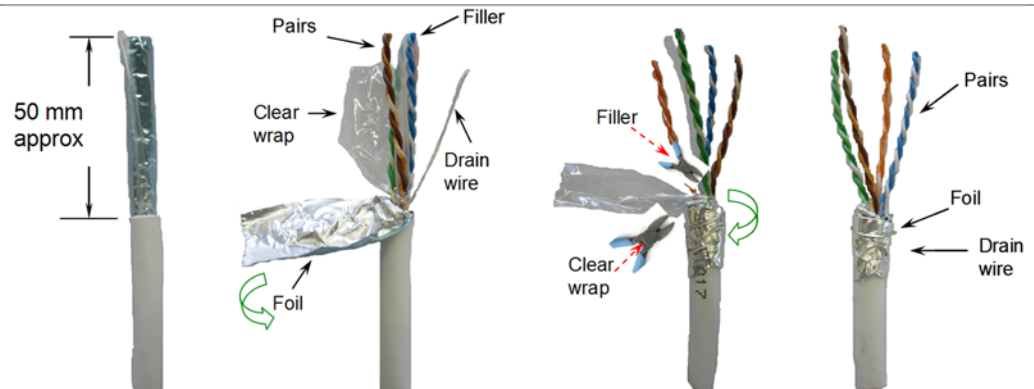

ASSEMBLY INSTRUCTION

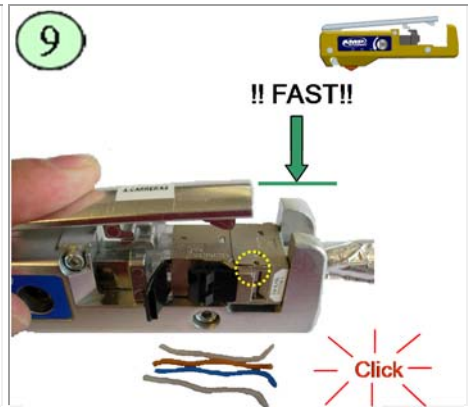
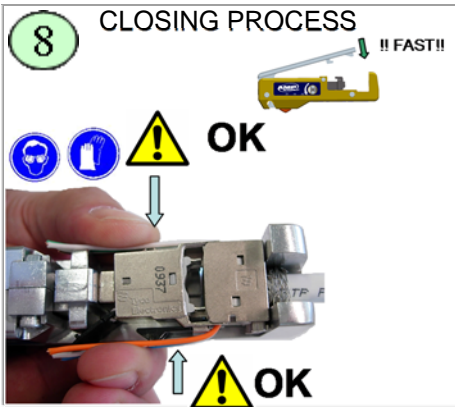
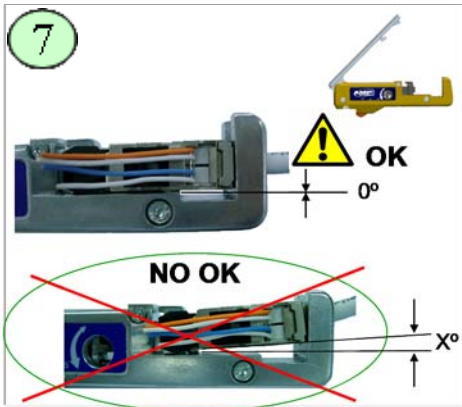
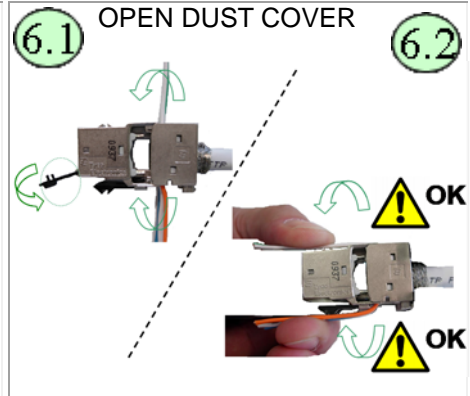
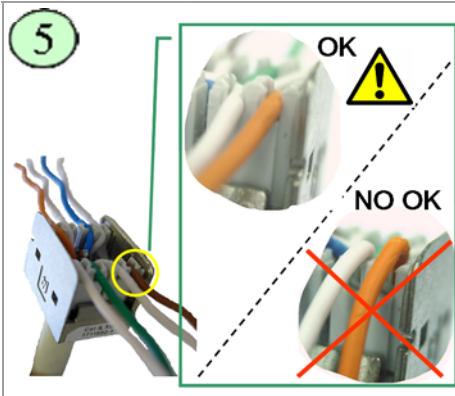
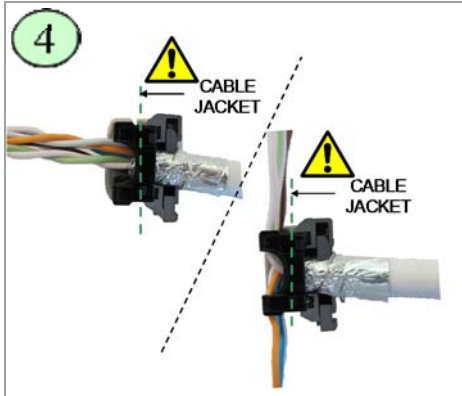
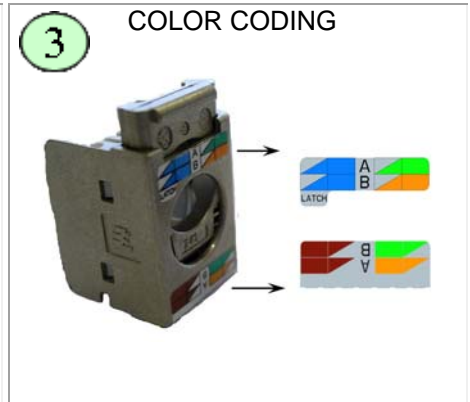
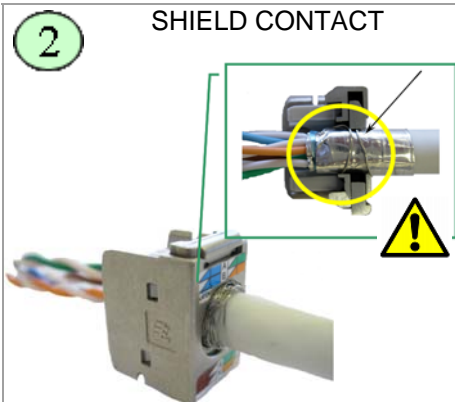
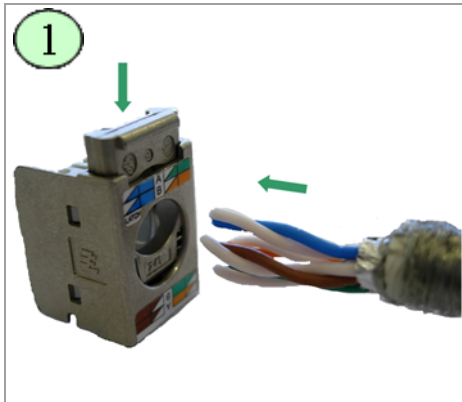

RE-OPENING INSTRUCTION

